

Operating Room Solutions - BARRIER® Surgical Drapes

Contents

BARRIER® Surgical Drapes	05	BARRIER® Primary and Primary Plus Drapes	26
Key to codes and materials	06	Primary Drapes	27
Key to materials	07	Universal sets basic	28
Universal sets	08	Paediatric set basic	28
Split sheets	09	Mayo stand cover	28
OP-sheets	10	Adhesive OP-Towels/Sheets	28
OP-towels	11	OP-Towel	28
Aperture drapes	12	Table cover	29
Specialty drapes and sets	13	Adhesive aperture drape, variable	29
Angiography	13	Adhesive aperture drapes	29
Cardiovascular	14	Primary Plus Drapes	30
ENT/Dental	15	Universal sets standard	30
General/Abdominal	16	Extremity sets	30
Gynaecology	17	Extremity drape	31
Neuro	18	Hand set	31
Obstetric	19	Split sheet set	31
Ophthalmic	20	Split sheets	31
Orthopaedic	21	Adhesive OP-Towels/Sheets	31
Urology	23	BARRIER® Sustainable ISCC drapes	32
Supplementaries	24		



We are Mölnlycke, a world-leading medical solutions company

Mölnlycke Health Care is a world-leading MedTech company that specialises in sustainable solutions for wound care and surgical procedures. Mölnlycke® products and solutions are used daily by hospitals, healthcare providers and patients in over 100 countries around the world. Founded in 1849, Mölnlycke is headquartered in Sweden and owned by Investor AB. Investor AB is listed on NASDAQ OMX Stockholm

We collaborate with customers to understand their needs. We design and supply medical solutions to enhance performance at every point of care – from the operating theatre to the home.

Improving performance at every point of care

This is what motivates us every day. We focus on the details that make our solutions more effective. All so that healthcare professionals can perform at their best, and achieve the best clinical and health-economic outcomes.

We do it by....

Listening

We collaborate with healthcare professionals and patients to understand their needs. Then we design solutions that meet them.

Generating evidence

Using a scientific approach, we generate clinical and health-economics evidence proving that our solutions are cost effective, and that they support better outcomes.

Continuously improving

We're always on the lookout for new ways to improve. We focus on the details that make our solutions more effective, improve outcomes and offer better value for money.

Educating

We're always learning. And we share our knowledge through in-person training, videos, demonstrations and online and offline seminars.

We collaborate with specialists to shape healthcare policies and protocols.

Building relationships

We develop long-term trusted relationships and partnerships with healthcare professionals, healthcare organisations and industry bodies.

We understand how important trust is, and we do everything we can to build and maintain it.



BARRIER® Surgical Drapes

Through the comprehensive range of procedure specific products, Mölnlycke can provide you with innovative product solutions designed to offer the optimal combination of protection and functionality. All BARRIER drapes are 100% impermeable and designed to ensure the best possible patient protection by providing an excellent barrier against microbial migration.

Effective infection control is achieved through impermeable materials, while effective fluid control is obtained through absorption or fluid collection pouches – allowing for a drier working area. Our attention to detail also ensures that all foldings are designed for precise aseptic handling and easy application.

All products and solutions within the BARRIER range of surgical drapes are developed and designed to facilitate the everyday work of the operating theatre.

The BARRIER products also come complete with the best available service and support including both training and supply and logistic solutions all according to the customers' need.

BARRIER is well known in Australia and New Zealand and is Europe's leading brand in single-use surgical drapes. We are setting the standard with a range that fulfills the different needs in the operating theatre.

For Mölnlycke and the BARRIER range, our strong commitment is to health care professionals and to patients undergoing treatment.

Key to codes and materials

Drape set description

Pieces in Retailer

Pieces in Carton

Reference number/ re-order code

Universal Set Standard ISCC **7/14** **60340**

Ref. No.	Items	Description
-	4	Cellulose Towel 18x25cm
910598	2	Adhesive OP-Towel
911500	1	OP-Tape 9x49cm
967774	2	Adhesive OP Sheet 175x150cm
90190	1	Table Cover 150x190 cm, abs. 75x190 cm

Reference number
Number
of Items
Description

Non sterile
reference number
of set content

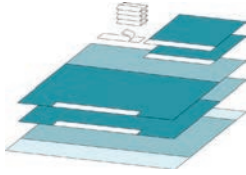
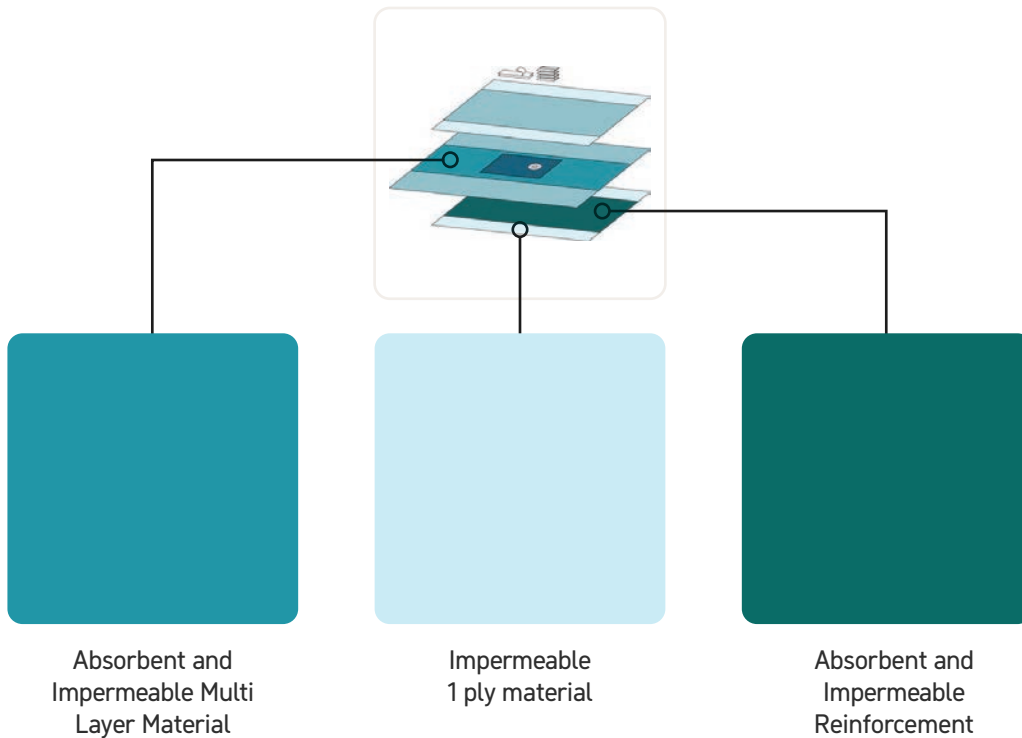
Key to codes and materials

BARRIER®
SURGICAL DRAPES



Elastic Film



Clear Plastic Film



Incise film

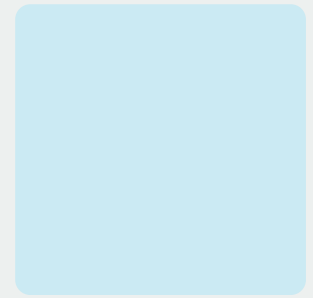

Impermeable
1 ply material



Absorbent and Impermeable
2 ply material



Absorbent and Impermeable
Multi Layer material

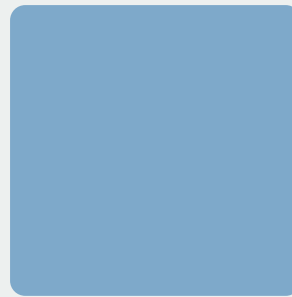

Absorbent and Impermeable
2 ply material



Highly Fluid Repellent
material*

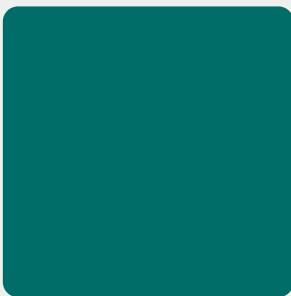

Absorbent and Impermeable
Reinforcement*



Highly Absorbent Patch +
Absorbent 1 ply Material



Flexible and conformable
adhesive edges, allowing
effective draping of all
contours of the body

Universal Sets

BARRIER®
SURGICAL DRAPES

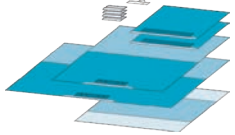
Universal Set Standard		6/12	66200
Ref. No.	QTY	Description	
	76520	2	Adhesive towel 120x100 cm
	-	4	Cellulose towel 18x25 cm
	911500	1	Op-tape 9x49 cm
	937771	1	Adhesive op-sheet reinforced 240x175 cm
	967782	1	Adhesive op-sheet 300x175 cm
	90190	1	Table cover 150x190 cm 75x190 cm absorbent

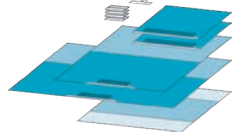
Universal Set Standard		6/12	699054
Ref. No.	QTY	Description	
	-	1	Mayo Stand Cover 79x145cm, abs. 65x85cm
	910200	2	Adhesive OP-Towel 90x75cm, patched
	-	4	Cellulose Towel 18x25cm
	-	1	OP-Tape 9x49cm
	967772	1	Adhesive OP-Sheet 175x175cm, patched
	967773	1	Adhesive OP-Sheet 240x150cm, patched
	90190	1	Table Cover 150x190 cm, abs. 75x190 cm

NZ ONLY

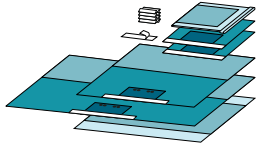
Universal Set Standard		5/10	699140
Ref. No.	QTY	Description	
	-	1	Mayo Stand Cover 79x145cm, abs. 65x85cm
	947069	2	Adhesive OP-Towel 100x100cm, patched
	-	4	Cellulose Towel 18x25cm
	911500	1	OP-Tape 9x49cm
	967772	1	Adhesive OP-Sheet 175x175cm, patched
	967782	1	Adhesive OP-Sheet 300x175cm, patched
	90190	1	Table Cover 150x190cm, abs. 75x190cm

AUS ONLY

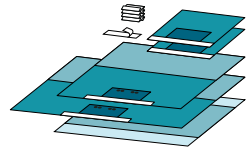
Universal Set Standard		6/12	699354
Ref. No.	QTY	Description	
	947069	2	Adhesive OP-Towel 100x100cm, patched
	-	4	Cellulose Towel 18x25cm
	911500	1	OP-Tape 9x49cm
	967772	1	Adhesive OP-Sheet 175x175cm, patched
	967773	1	Adhesive OP-Sheet 240x150cm, patched
	90190	1	Table Cover 150x190cm, abs. 75x190cm

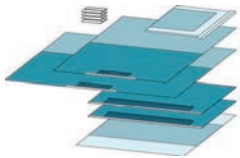
Universal Set Special		3/6	66100
Ref. No.	QTY	Description	
	-	1	Mayo stand cover 79x145cm, abs. 65x85cm
	76510	2	Adhesive Op-sheet Reinforced 200x100 cm
	-	4	Cellulose Towel 18x25cm
	937771	1	Adhesive OP-Sheet Reinforced 240x175cm
	967782	1	Adhesive OP-Sheet 300x175cm
	90210	1	Table Cover 150x210cm, abs. 75x210cm
-	1	Suture Bag 16x28cm	

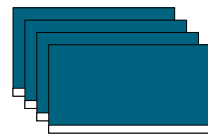
Universal Set Basic		24/48	66530
Ref. No.	QTY	Description	
	66530	4	Adhesive OP-Towel 50x28cm Adhesive NARROW

Split Sheets

BARRIER®
SURGICAL DRAPES

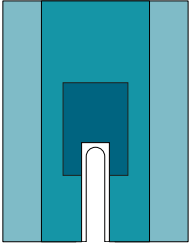
Split Sheets Patched			
	Ref. No.	Description	Ret/Crtn*
	60502 NZ Only	Split Sheet 200x150cm, adh. split 7x65cm, patch 70x100cm	10/40
	60503 NZ Only	Split Sheet 200x260cm, adh. split 7x102cm, patch 70x100cm	14/28
	60504	Split Sheet 200x260cm, adh. split 20x102cm, patch 70x100cm	14/28
	60506	Split Sheet 200x290cm, adh. split 7x102cm, patch 70x100cm	12/24

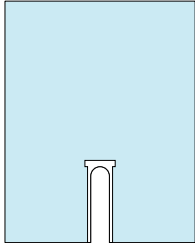
Split Sheet Plastic			
	Ref. No.	Description	Ret/Crtn*
	2750	Split Sheet (plastic) 150x193cm, adh. split 15x61cm	20/40

*Ret/Crtn - Retailer/Carton

OP-Sheets

BARRIER®
SURGICAL DRAPES

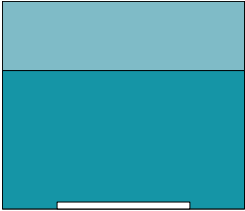
Adhesive OP-Sheet 3-Ply			
	Ref. No.	Description	Ret/Crtn*
	778200	Adhesive OP-Sheet 300x175cm	9/18
	920496	Adhesive OP-Sheet 175x175cm	18/36

OP-Sheet 3-Ply			
	Ref. No.	Description	Ret/Crtn*
	777900	OP-Sheet 90x150cm	30/60
	778000	OP-Sheet 150x175cm	18/36
	778100 AUS Only	OP-Sheet 150x240cm	14/28

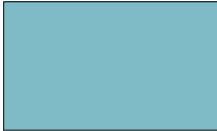
OP-Sheet 2-Ply			
	Ref. No.	Description	Ret/Crtn*
	80649015	OP-Sheet 90x150cm	18/72

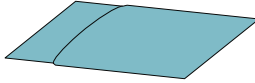
Under Buttocks Drape			
	Ref. No.	Description	Ret/Crtn*
	828900 NZ Only	Under Buttocks Drape 75x100cm	44/88

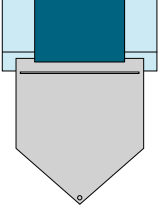
Under Buttocks Drape			
	Ref. No.	Description	Ret/Crtn*
	229	Under Buttocks Drape w/pouch 85x120cm	20/40

*Ret/Crtn - Retailer/Carton

OP-Towels

BARRIER®
SURGICAL DRAPES

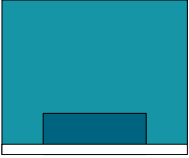
Adhesive OP-Towel Patched			
	Ref. No.	Description	Ret/Crtn*
	706800 NZ Only	Adhesive OP-Towel 90x75cm, patched	45/90

Adhesive OP-Towel			
	Ref. No.	Description	Ret/Crtn*
	706100	Adhesive Absorbent Pad 55x70cm	40/80

Adhesive OP-Towel 3-Ply			
	Ref. No.	Description	Ret/Crtn*
	706500	Adhesive OP-Towel 75x75cm	35/210
	706900	Adhesive OP-Towel 100x100cm	43/86

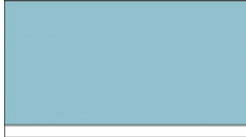
Adhesive OP-Towel			
	Ref. No.	Description	Ret/Crtn*
	66530	Narrow adhesive OP-Towel 50x28cm, adhesive width 25mm, 4pcs	24/48

*Ret/Crtn - Retailer/Carton

Aperture Drapes

BARRIER®
SURGICAL DRAPES

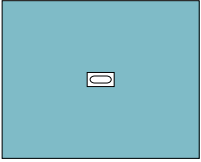
Adhesive Aperture Drape			
	Ref. No.	Description	Ret/Crtn*
	708850	Adhesive Aperture Drape 150x180cm, ap. 5x15cm	28/56

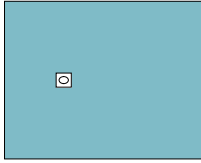
Adhesive Aperture Drape			
	Ref. No.	Description	Ret/Crtn*
	708880	Adhesive Aperture Drape 200x280cm, ap. 14x14cm, 124cm from top	14/28

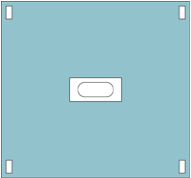
Epidural Drape			
	Ref. No.	Description	Ret/Crtn*
	915447	Adhesive Aperture Drape 75x80cm, ap. 6x15cm	36/72

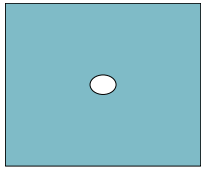
Adhesive Aperture Drape			
	Ref. No.	Description	Ret/Crtn*
	906544	Aperture Drape 50x60cm, ap. 6x8cm	70/140

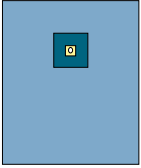
Adhesive Aperture Drape			
	Ref. No.	Description	Ret/Crtn*
	61340 NZ Only	Adhesive Aperture Drape 200x300cm, apertured incise 12x16.5 cm	14/28

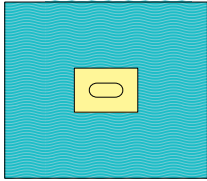
Adhesive Aperture Drape			
	Ref. No.	Description	Ret/Crtn*
	85601	Adhesive Aperture Drape 115x100cm, incise 8x19cm	20/40

*Ret/Crtn - Retailer/Carton

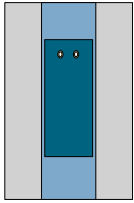
Angiography Drape			
	Ref. No.	Description	Ret/Crtn*
	65211	Angiography Drape 240x370cm, Reinforcement 90x220cm, ap. 6x9cm (2), wrapped	8/16

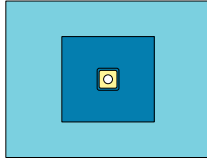
Brachial Angiography Drape			
	Ref. No.	Description	Ret/Crtn*
	65212 NZ Only	Brachial Angiography Drape 115x150cm, Reinforcement 70x70cm, ap 6cm	24/48

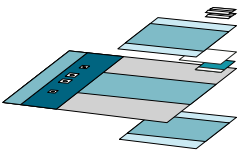
Angiography Radials Set			
	Ref. No.	QTY	Description
	90150	1	Table Cover 150x150 cm Absorbent
	-	2	Cellulose Towels 18x25cm
	-	1	Absorbent Towel 56x80cm
	947064	1	Adhesive OP-Towel 50x50cm 3PLY, Adhesive
	958284	1	Angiography Drape 240x330cm, Aperture 5x7cm (2), 7x9cm (2), Adhesive, Femoralis Length Fold, Patched, Radialis
	90150	1	Table Cover 150x150cm Absorbent

*Ret/Crtn - Retailer/Carton

Cardiovascular

BARRIER®
SURGICAL DRAPES

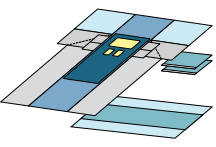
Hybrid Cardiovascular Set		4/8	61800
Ref. No.	QTY	Description	
 <p>NZ ONLY</p>	71800	1	Hybrid Cardiovascular Drape 240/300x450cm, incise area 60x40 cm and 15x27cm (2), 2 adhesive towel 75x75cm
	90190	1	Table Cover 150x190cm, 75x190cm absorbent
	910598	2	Adhesive OP-Towel 75x75cm

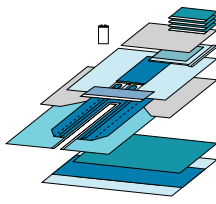
Cardiovascular Universal Set		2/4	61920
Ref. No.	QTY	Description	
	947063	4	Adhesive towel 75x50cm
	-	1	Suture bag 16x28cm
	9544	1	Mayo stand cover 58x137cm, 50x60 cm absorbent
	71930	1	Bilateral split sheet 180x200cm, split 17x50 cm (2)
	71920	1	Vu-thru cardiovascular split sheet 205/280x340 cm, split 15x219cm
	910186	1	OP-sheet 150x240cm
	99280	1	Reinforced table cover 190x280cm, 90x280cm absorbent
	-	1	OP-Sheet (plastic) 110x145cm

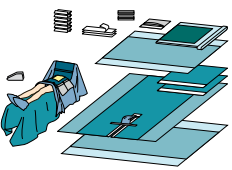
Cardiovascular Set		3/6	694640
Ref. No.	QTY	Description	
	996109	1	Reinforced Mayo Stand Cover 79x145cm, abs. 65x85cm
	-	6	Cellulose Towel 18x25cm
	90190	1	Table Cover 150x190cm, abs. 75x190cm
	-	1	Defibrillator Bag 33x38cm
	824098	2	Tube Holder 2.5x30cm, adh.
	911500	3	OP-Tape 9x49cm
	941005	2	Foot Cover 36x28cm
	991005	2	Foot Cover 36x28cm
	910598	2	Adhesive OP-Towel 75x75cm
	988795	1	Split Sheet w/perineal cover 200x260cm, adh. split 20x102cm
	966946	1	Thoracic Drape 200/300x330cm, incise 32x40cm
	90240	1	Table Cover 150x240cm, abs. 75x240cm

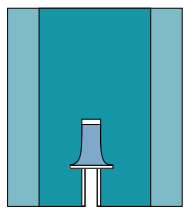
Lower Vascular Drape		Ref. No.	Description	Ret/Crtn*
	824700	Split Sheet w/perineal cover 200x260cm, adh. split 20x102cm	12/24	

*Ret/Crtn - Retailer/Carton

ENT Set		7/14	65000
Ref. No.	QTY	Description	
-	1	Mayo Stand Cover 79x145cm, abs. 65x85cm	
-	4	Cellulose Towel 18x25cm	
911500	2	OP-Tape 9x49cm	
910519	1	OP-Towel 75x90cm	
930200	1	Adhesive OP-Towel 90x75cm	
70509	1	Split Sheet 150x260cm, adh. split 7x65cm, patched	
90190	1	Table Cover 150x190cm, abs. 75x190cm	

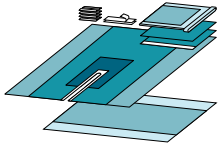

Head Turban Set		7/14	80574671
Ref. No.	QTY	Description	
8085	1	Adhesive Head Drape w/ turban wrap 150x94cm, 128x79cm	
75013	1	Adhesive OP-Sheet 175x200cm, adhesive 2,5cm	
91210	1	Table Cover 150x210cm, abs. 75x210cm	

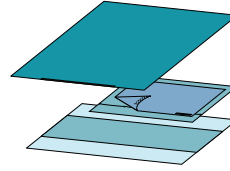

Head Turban Set		7/14	80011660
Ref. No.	QTY	Description	
8085	1	Adhesive Head Drape w/ turban wrap 150x94cm, 128x79cm	
75013	1	Adhesive OP-Sheet 175x200cm, adhesive 2,5cm	
-	1	Wrap 90x90cm	

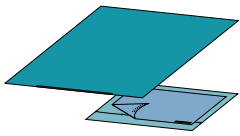

ENT Set		9/18	65020
Ref. No.	QTY	Description	
911510	1	OP-Tape 9x49cm	
75014	1	Adhesive Aperture Drape 200x240cm, apertured incise 6x8cm	
90190	1	Table Cover 150x170cm, 75x170cm absorbent	
-	-	Wrapping Paper 90x90cm	

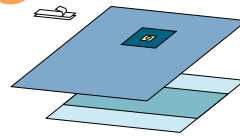

NZ ONLY

General Abdominal

BARRIER®
SURGICAL DRAPES

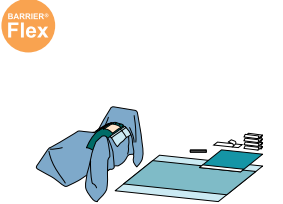
Laparoscopy Set Abdo-Perineal		5/10	694240
Ref. No.	QTY	Description	
	-	4	Cellulose Towel 18x25cm
	911500	1	OP-Tape 9x49cm
	824098	1	Tube Holder 2.5x30cm, adh.
	910598	1	Adhesive OP-Towel 75x75cm
	944200	1	Laparoscopy Drape 250/175/270x260cm, adh. ap. 25x30cm and ap. 13x24cm
	90190	1	Table Cover 150x190cm, abs. 75x190cm

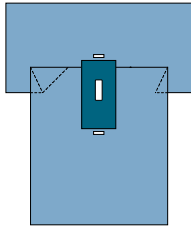
Laparotomy Drape		Ref. No.	Description	Ret/Crtn*
	61320	Laparotomy Drape 200/270x315, ap. 10x30cm	9/18	
	61330	Laparotomy Drape 200/270x320, ap. 23x36cm	8/16	

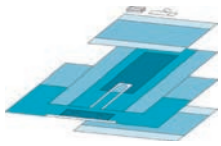
Varicose Vein Set		6/12	61400
Ref. No.	QTY	Description	
	-	2	Cellulose towel 18x25cm
	90100	1	Table cover 100x150cm
	911500	1	Op-tape 9x49cm
	70512	1	Split sheet 200x260cm, split 20x102cm, patch 70x160cm
	76409	1	Adhesive op-sheet 240x175cm
	90190	1	Table cover 150x190cm, 75x190cm absorbent

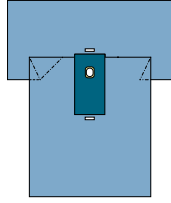
Paediatric Drape		Ref. No.	Description	Ret/Crtn*
	61310	Paediatric Drape 200/270x320cm, ap.10x14cm	9/18	

*Ret/Crtn - Retailer/Carton

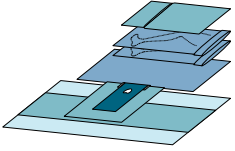
Lithotomy Set		6/12	61010
Ref. No.	QTY	Description	
	972890	1	Under Buttocks Drape 75x100cm
	906109	2	Lithotomy Leggings 75x120cm
	71000	1	Lithotomy Drape 75/150x170cm, adh. ap. 9x11cm
	90190	1	Table Cover 150x190cm, abs. 75x190cm

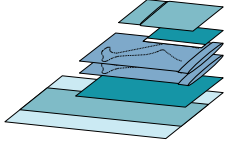
Lithotomy Set		6/12	251
Ref. No.	QTY	Description	
	972890	1	Under Buttocks Drape 75x100cm
	947063	1	Adhesive OP-Towel 75x50cm
	9855	2	Lithotomy Leggings 75x150cm
	910184	1	OP-Sheet 90x150cm
	90210	1	Table Cover 150x210cm, abs. 75x210cm

NZ ONLY

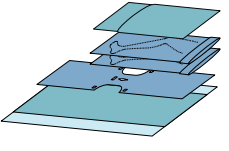
Gynaecology/Cystoscopy Set		9/18	902496
Ref. No.	QTY	Description	
	972890	1	Under Buttocks Drape 75x100cm
	906109	2	Lithotomy Leggings 75x120cm
	71000	1	Lithotomy Drape 75/150x170cm, adh. ap. 9x11cm
	90190	1	Table Cover 150x190cm, abs. 75x190cm

AUS ONLY

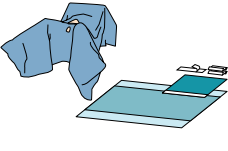
Gynaecology/Laparoscopy Set		6/12	696600
Ref. No.	QTY	Description	
	-	2	Cellulose Towel 18x25cm
	-	1	OP-Tape 9x49cm
	910598	1	Adhesive OP-Towel 75x75cm
	956966	1	Laparoscopy Drape 250/270x270 cm w/leggings, adh. ap. 26x20cm, 7.5x13cm
	90190	1	Table Cover 150x190cm, abs. 75x190cm

NZ ONLY

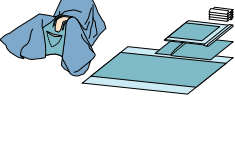
Urology/Gynaecology Set		5/10	905020
Ref. No.	QTY	Description	
	-	1	Mayo Stand Cover 79x145cm, abs. 65x85cm
	972890	1	Under Buttocks Drape 75x100cm
	-	4	Cellulose Towel 18x25cm
	990520	1	Urology/Gynaecology Drape 200/355x295cm, adh. ap. 17/8x28cm
	90190	1	Table Cover 150x190 cm, abs. 75x190cm

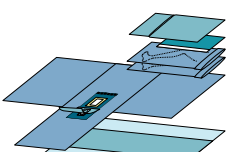
Laparoscopy Set Abdo-Perineal		5/10	61040
Ref. No.	QTY	Description	
	972890	1	Under Buttocks Drape 75x100cm
	947063	1	Adhesive Towel 75x50cm
	9855	2	XL Lithotomy Leggings 75x150cm
	71040	1	Gynaecology Drape 75/250x245cm, adh. ap. 25x18cm, ap. 6x15cm
	90210	1	Table Cover 150x210cm, abs. 75x210cm

Craniotomy Set		6/12	888142
Ref. No.	QTY	Description	
-	1	Mayo Stand Cover 79x145cm, abs. 65x85cm	
-	2	Cellulose Towel 18x25cm	
911500	1	OP-Tape 9x49cm	
-	4	Adhesive OP Towel, 50x50cm	
965524	1	Craniotomy Drape 230x300cm, incise 30x20cm	
90190	1	Table Cover 150x190cm, abs. 75x190cm	

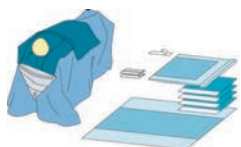

Craniotomy Drape			
Ref. No.	Description	Ret/Crtn*	
888442	Craniotomy Drape 280x295cm, incise 30x20cm	9/18	

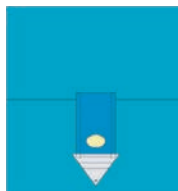

*Ret/Crtn - Retailer/Carton

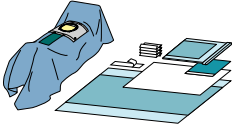
C-Section Set		4/8	903355
	Ref. No.	QTY	Description
	-	1	Mayo Stand Cover 79x145cm, abs. 65x85cm
	-	4	Cellulose Towel 18x25cm
	911500	1	OP-Tape 9x49cm
	947064	1	Adhesive OP-Towel 50x50cm
	910433	1	Baby Blanket 90x120cm
	904743	1	C-Section Drape 175/250x300cm, folded length wise, incise, 38x32cm
	90190	1	Table Cover 150x190cm, abs. 75x190cm

NZ ONLY

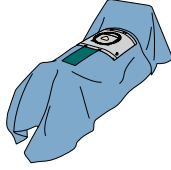
C-Section Drape W/ Aperture Incise			
	Ref. No.	Description	Ret/Crtn*
	65040	C-Section Drape 175/250x300cm, incise area 38x32cm, ap.18x16cm, wrapped	6/12

AUS ONLY

*Ret/Crtn - Retailer/Carton

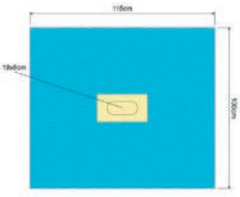
Ophthalmic Drapes			
	Ref. No.	Description	Ret/Crtn*
	85601	Ophthalmic drapes 115×100cm 19x8cm aperture	20/40

NZ ONLY

Features

- SMS material
- Impermeable in the critical area
- Low linting
- Breathable material
- Full incise drape in aperture

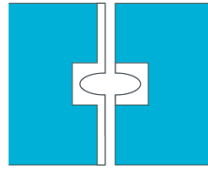
Ophthalmic Drapes			
	Ref. No.	Description	Ret/Crtn*
	706630	Ophthalmic drapes 75×100cm 11x12.5cm aperture	30/60

NZ ONLY

Features

- 2-ply laminate material
- Impermeable all over
- Low linting
- Adhesive aperture
- Variable aperture to suit all clinical requirements

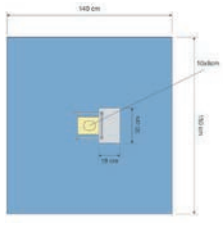
Ophthalmic Drapes			
	Ref. No.	Description	Ret/Crtn*
	85606	Ophthalmic drapes 140×150cm 10x8cm aperture	16/32

NZ ONLY

Features

- 2-ply laminate material
- Impermeable all over material
- Low linting
- Nose bridges to facilitate breathing
- Fluid collection pouch 30cm x 18cm
- Full incise drape in aperture

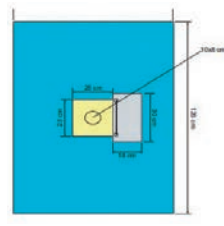
Ophthalmic Drapes			
	Ref. No.	Description	Ret/Crtn*
	85617	Ophthalmic drapes 100×120cm 10x8cm aperture	24/48

NZ ONLY

Features

- SMS material
- Impermeable in the critical area
- Low linting
- Breathable material
- Fluid collection pouch 30cm x 18cm
- Full incise in aperture

*Ret/Crtn - Retailer/Carton

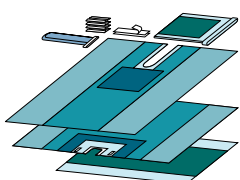
Shoulder Set		4/8	60001
Ref. No.	QTY	Description	
	996109	1	Reinforced Mayo Stand Cover 79x145cm, abs. 65x85cm
	-	4	Cellulose Towel 18x25cm
	70007	1	Lower Shoulder Split Sheet 230x295 cm, split 10x70 cm
	946111	1	Stockinet 22x75cm
	911500	2	OP-Tape 9x49cm
	70005	1	Upper Shoulder Split Sheet 240x170cm, split 15x45cm
	95190	1	Reinforced Table Cover 150x190cm, abs. 75x190cm

NZ ONLY

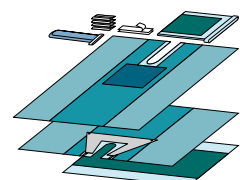
Shoulder Set W/Pouch		4/8	60002
Ref. No.	QTY	Description	
	996109	1	Reinforced Mayo Stand Cover 79x145cm
	26153	4	Cellulose Towel 18x25cm
	7007	1	Lower shoulder split sheet 230x295cm, split 10x70cm
	946111	1	Stockinet 22x75cm
	911500	2	OP-Tape 9x49cm
	70006	1	Upper Shoulder Split Sheet 240x170cm, split 15x45cm
	95190	1	Reinforced Table Cover 150x190cm, abs. 75x190cm

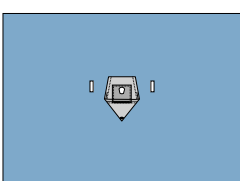
Beach Chair Shoulder Drape				
Ref. No.	Description	Ret/Crtn*		
	60004	Beach Chair Shoulder Drape 400x220cm, ap. 10x10cm elastic, wrapped	5/10	

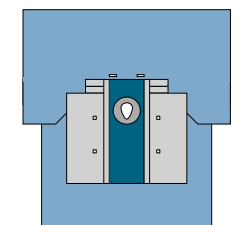
Hip Drape W/Dislocation Bags				
Ref. No.	Description	Ret/Crtn*		
	60601	Hip drape w/ dislocation bags 220/300x340cm, ap. 18x22cm elastic, wrapped	4/8	

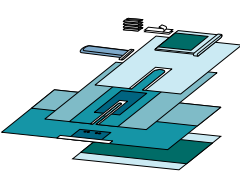
Hip Set		4/8	60606
Ref. No.	QTY	Description	
	996109	1	Reinforced Mayo Stand Cover 79x145cm, abs. 65x85cm
	-	4	Cellulose Towel 18x25cm
	9475	1	Split Sheet (plastic) 150x193cm, adh. split 15x61cm
	946112	1	Stockinet, 32x120cm
	-	2	OP-Tape, 9x49cm
	70503	1	Split Sheet 200x260cm, adh. split 7x102cm, patched
	76409	1	Adhesive OP-sheet 240x175cm, patched
	95190	1	Reinforced Table Cover 150x190cm, abs. 75x190cm

NZ ONLY

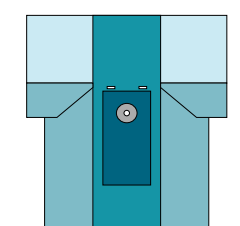
Hip Drape				
Ref. No.	Description	Ret/Crtn*		
	60600	Hip Drape 230/300x330cm, ap. 18x22cm elastic	6/12	

NZ ONLY

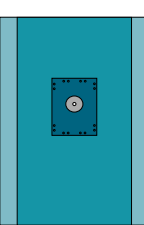
Hand/Foot Drape				
Ref. No.	Description	Ret/Crtn*		
	60309	Hand/Foot Drape 230x315cm, ap. 3.5cm elastic	11/22	

*Ret/Crtn - Retailer/Carton

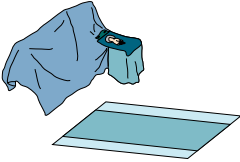
Hand Set		6/12	60305
Ref. No.	QTY	Description	
 70310	1	Hand Drape 150/370x280cm, ap. 3.5cm elastic	
90190	1	Table Cover 150x190cm, abs. 75x190cm	

Hand Drape			
Ref. No.	Description	Ret/Crtn*	
 60310	Hand Drape 150/370x280cm, ap. 3.5cm elastic	7/14	

Knee Arthroscopy Drape			
Ref. No.	Description	Ret/Crtn*	
 60104	Knee Arthroscopy Drape 220x320cm, ap. 7 and 5cm elastic	5/10	

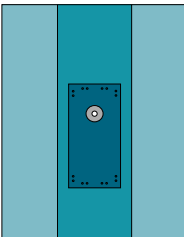
Extremity Drape			
Ref. No.	Description	Ret/Crtn*	
 60211 AUS Only	Extremity Drape 200x300cm, ap. 7cm elastic	11/22	
60213	Extremity Drape 230x315cm, ap. 7cm elastic	10/20	
60214	Extremity Drape 200/300x320cm, ap. 7cm elastic	8/16	

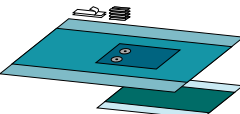
Extremity Set, Bilateral Leg		7/14	60301
Ref. No.	QTY	Description	
-	4	Cellulose Towel 18x25cm	
-	2	OP-Tape 9x49cm	
 70313	1	Bilateral Leg Drape 200x300cm, ap. 7cm elastic (2)	
95190	1	Reinforced Table Cover 150x190cm, abs. 75x190cm	

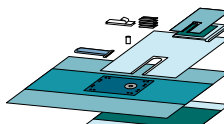
Extremity Set		4/8	60207
Ref. No.	QTY	Description	
 9214	1	Preparation Pad 120x150cm, adh. split 10x36cm	
996109	1	Reinforced Mayo Stand Cover 79x145cm, abs. 65x85cm	
-	4	Cellulose Towel 18x25cm	
9475	1	Split Sheet (plastic) 150x193cm, adh. split 15x61cm	
946111	1	Stockinet, 22x75cm	
-	2	OP-Tape, 9x49cm	
70210	1	Extremity Drape 250x315cm, ap. 7cm elastic	
-	1	Suture Bag, 16x28cm	
95190	1	Reinforced Table Cover 150x190cm, abs. 75x190cm	

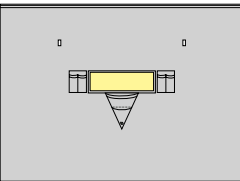
Vertical Isolation Drape			
Ref. No.	Description	Ret/Crtn*	
 826020	Vertical Isolation Drape 330x240cm, incise 40x30cm	10/20	

*Ret/Crtn - Retailer/Carton

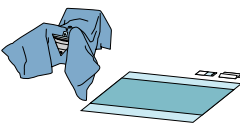
TUR Set		7/14	888222	
		Ref. No.	QTY	Description
	-	1	Cellulose Towel 18x25cm	
	904762	1	Tube Holder 9x18cm, adh	
	965520	1	TUR Drape 175/270x180cm w/ pouch , apertures 8cm and 5cm, finger cot.	
	90190	1	Table Cover 150x190cm, abs. 75x190cm	

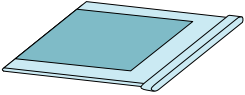
Mayo Stand Cover			
	Ref. No.	Description	Ret/Crtn*
	1244	Mayo Stand Cover 58x137cm, abs. 50x60cm	50/100



Mayo Stand Cover			
	Ref. No.	Description	Ret/Crtn*
	610900	Reinforced Mayo Stand Cover 79x145cm, abs. 65x85cm	20/60
	80000552 AUS Only	Reinforced Mayo Stand Cover 79x145cm, abs. 61x85cm, wrapped	22/44

Table Cover			
	Ref. No.	Description	Ret/Crtn*
	80100 AUS Only	Table Cover 100x150cm, abs. 75x150cm	40/80
	80215	Table Cover 150x210cm, abs. 75x210cm, wrapped	22/44

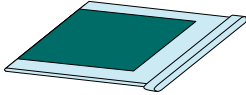

Reinforced Table Cover			
	Ref. No.	Description	Ret/Crtn*
	85215	Reinforced Table Cover 150x210cm, abs. 75x210cm, wrapped	18/36
	89285	Reinforced Table Cover 190x280cm, abs. 90x280cm, wrapped	12/24

Table Cover			
	Ref. No.	Description	Ret/Crtn*
	63690	Table Cover Primary 150x190 cm	30/60

Irrigation Pouch			
	Ref. No.	Description	Ret/Crtn*
	5218	Irrigation Pouch 50x60cm, adh.	8/16

*Ret/Crtn - Retailer/Carton

OP-Tape			
	Ref. No.	Description	Ret/Crtn*
	381045	OP-Tape 9x49cm, 2 pcs	120/480

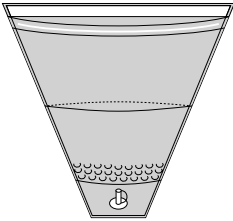
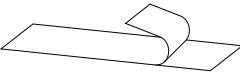
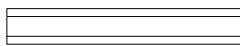
Tube Holder			
	Ref. No.	Description	Ret/Crtn*
	708131	Tube Holder 2.5x30cm, adh.	50/200

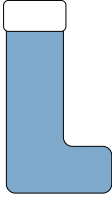
Stockinet W/ Liner			
	Ref. No.	Description	Ret/Crtn*
	273	Stockinet 23x107cm, wrapped	6/24
	274	Stockinet 31x122cm, wrapped	5/20

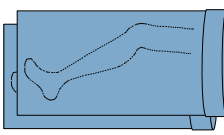
Lithotomy Leggings			
	Ref. No.	Description	Ret/Crtn*
	255	Lithotomy Leggings 75x150cm, 2pcs, wrapped	22/44

*Ret/Crtn - Retailer/Carton



BARRIER® PRIMARY Surgical Drapes

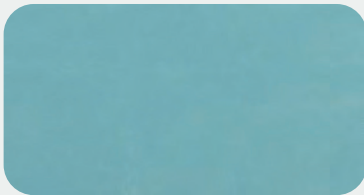

BARRIER® PRIMARY

+



REINFORCEMENT

=

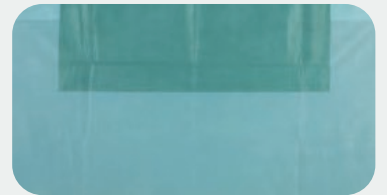

BARRIER® PRIMARY PLUS

BARRIER® PRIMARY 2-layer drapes from Mölnlycke®

BARRIER® PRIMARY surgical draping assortment is compliant with the requirements in the EN13795 for high performance drapes.

BARRIER PRIMARY drape material is made by coextrusion laminate technique to provide the required strength of the material.

BARRIER® PRIMARY PLUS offers an additional third layer of reinforcement to suit procedures requiring extra fluid.

BARRIER® PRIMARY

+

REINFORCEMENT

=

BARRIER® PRIMARY
PLUS

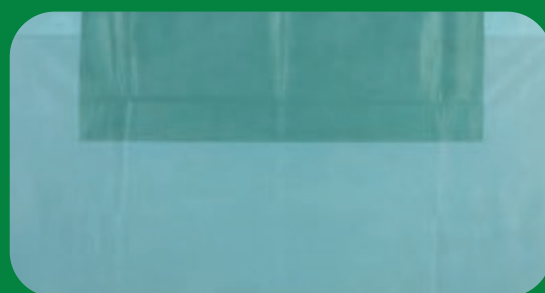

- ✓ EN13795 for surgical drapes
- ✓ Impermeable all over
- ✓ Absorbent all over
- ✓ Three layer packaging system
- ✓ Reinforced layer on BARRIER PRIMARY PLUS codes



63710 Universal Set Basic PRIMARY				RET/CRTN 5/10
QTY	Product Name	Size (cm)	Descriptive Feature	
1	Mayo stand cover	79 x 145	Reinforced/Absorbent	
2	Adhesive OP-towel	90 x 75	2-ply, Adhesive edges	
4	Cellulose towel	17 x 8	Absorbent	
1	OP-tape	9 x 50	Adhesive	
1	Adhesive OP-sheet	180 x 180	2-ply, Adhesive edges	
1	Adhesive OP-sheet	240 x 150	2-ply, Adhesive edges	
1	Table cover	150 x 190	Absorbent	
1	Tube holder	2.5 x 30	Hook and loop	

63711 Universal Set Basic PRIMARY				RET/CRTN 11/22
QTY	Product Name	Size (cm)	Descriptive Feature	
4	Adhesive OP-towel	90 x 75	2-ply, Adhesive	
2	Cellulose towel	17 x 8	Absorbent	
1	Table cover	150 x 190	Absorbent	
1	Tube holder	2.5 x 30	Hook and loop	

63720 Paediatric Set Basic PRIMARY				RET/CRTN 5/10
QTY	Product Name	Size (cm)	Descriptive Feature	
1	Mayo stand cover	79 x 145	Reinforced/Absorbent	
2	Adhesive OP-towel	75 x 75	2-ply, Adhesive edge 2.5cm wide	
4	Cellulose towel	17 x 8	Absorbent	
1	OP-tape	9 x 50	Adhesive	
1	Adhesive OP-sheet	180 x 180	2-ply, Adhesive edge 2.5cm wide	
1	Adhesive OP-sheet	240 x 150	2-ply, Adhesive edge 2.5cm wide	
1	Table cover	150 x 190	Absorbent	
1	Tube holder	2.5 x 30	Hook and loop	

Mayo Stand Cover				RET/CRTN 14/28
Ref. Sterile	Product Name	Size (cm)	Descriptive Feature	
63046	Mayo stand cover	95 x 185	Extra reinforced/absorbent	

Adhesive OP-Towels/Sheets PRIMARY				
Ref. Sterile	Product Name	Size (cm)	Descriptive Feature	RET/CRTN
63611	Adhesive OP-towel	75 x 75	2-ply Adhesive	42/84
63612	Adhesive OP-towel	75 x 100		33/66
63613	Adhesive OP-towel	90 x 75		60/120
63614	Adhesive OP-towel	100 x 100		70/140
63615	Adhesive OP-sheet	180 x 150		26/52
63616	Adhesive OP-sheet	240 x 150		22/44



OP-Towel PRIMARY				RET/CRTN 45/90
Ref. Sterile	Product Name	Size (cm)	Descriptive Feature	
63619	OP-Towel	90 x 75	2-ply	

*Ret/Crtn - Retailer/Carton

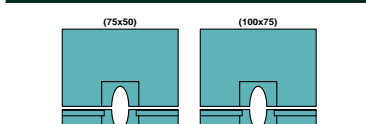
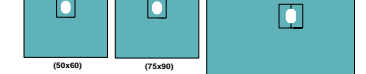

Table Cover PRIMARY PLUS **RET/CRTN 30/60**

	Ref. Sterile	Product Name	Size (cm)	Descriptive Feature
	63690	Table Cover	150 x 190	2-ply

Adhesive Aperture Drape, Variable PRIMARY

	Ref. Sterile	Product Name	Size (cm)	Descriptive Feature	RET/CRTN
	63628	Adhesive aperture drape, variable	75 x 50	2-ply, variable size	56/112
	63629	Adhesive aperture drape, variable	100 x 75	2-ply, variable size	36/72

Adhesive Aperture Drape PRIMARY

	Ref. Sterile	Product Name	Size (cm)	Descriptive Feature	RET/CRTN
	63621	Adhesive aperture drape	75 x 90	2-ply, aperture 9 x 6cm	36/72
	63623	Adhesive aperture drape	50 x 60	2-ply, aperture 8 x 6cm	90/180
	63624	Adhesive aperture drape	150 x 120	2-ply, aperture 7 x 5cm	58/116

Adhesive Aperture Drape PRIMARY **RET/CRTN 48/96**

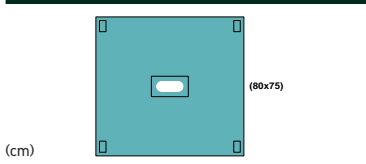
	Ref. Sterile	Product Name	Size (cm)	Descriptive Feature
	63625	Adhesive aperture drape	80 x 75	2-ply, aperture 6 x 15cm

*Ret/Crtn - Retailer/Carton

63701 Universal Set Standard PRIMARY PLUS			RET/CRTN 6/12
QTY	Product Name	Size (cm)	Descriptive Feature
2	Adhesive OP-towel	90 x 75	2-ply, Adhesive edges, Reinforced patched area 60 x 25cm
4	Cellulose towel	17 x 8	Absorbent
1	OP-tape	9 x 50	Adhesive
1	Adhesive OP-sheet	180 x 180	2-ply, Adhesive edges, Reinforced patched area 60 x 25cm
1	Adhesive OP-sheet	240 x 150	2-ply, Adhesive edges, Reinforced patched area 60 x 25cm
1	Table cover	150 x 190	Absorbent
1	Tube holder	2.5 x 30	Hook and loop

63702 Universal Set Standard PRIMARY PLUS			RET/CRTN 4/8
QTY	Product Name	Size (cm)	Descriptive Feature
2	Adhesive OP-towel	120 x 100	2-ply, Adhesive edges, Reinforced patched area 60 x 25cm
4	Cellulose towel	17 x 8	Absorbent
1	OP-tape	9 x 50	Adhesive
1	Adhesive OP-sheet	300 x 180	2-ply, Adhesive edges, Reinforced patched area 60 x 25cm
1	Adhesive OP-sheet	240 x 180	2-ply, Adhesive edges, Reinforced patched area 60 x 25cm
1	Table cover	150 x 190	Absorbent
1	Tube holder	2.5 x 30	Hook and loop

63700 Universal Set Standard PRIMARY PLUS			RET/CRTN 5/10
QTY	Product Name	Size (cm)	Descriptive Feature
1	Mayo stand cover	79 x 145	Reinforced/absorbent
2	Adhesive OP-towel	90 x 75	2-ply, Adhesive edges, Reinforced patched area 60 x 25cm
4	Cellulose towel	17 x 8	Absorbent
1	OP-tape	9 x 50	Adhesive
1	Adhesive OP-sheet	180 x 180	2-ply, Adhesive edges, Reinforced patched area 60 x 25cm
1	Adhesive OP-sheet	240 x 150	2-ply, Adhesive edges, Reinforced patched area 60 x 25cm
1	Table cover	150 x 190	Absorbent
1	Tube holder	2.5 x 30	Hook and loop

60711 Extremity Set PRIMARY PLUS			RET/CRTN 4/8
QTY	Product Name	Size (cm)	Descriptive Feature
1	Mayo stand cover	79 x 145	Reinforced/absorbent
2	Cellulose towel	17 x 8	Absorbent
1	OP-tape	9 x 50	Adhesive
1	Adhesive OP-sheet	75 x 75	2-ply, Adhesive edge 2.5cm wide
1	Extremity drape	225 x 300	2-ply Reinforced absorption patch (110 x 50cm) Flexible area (27 x 20cm) Extremity hole (diameter 7cm)
2	Table cover	150 x 190	Absorbent
1	Tube holder	2.5 x 30	Hook and loop

63730 Extremity Set PRIMARY PLUS			RET/CRTN 7/14
QTY	Product Name	Size (cm)	Descriptive Feature
1	Mayo stand cover	79 x 145	Reinforced/absorbent
1	Extremity drape	225 x 300	2-ply Reinforced absorption patch (110 x 50cm) Flexible area (27 x 20cm) Extremity hole (diameter 3.5cm)
1	Table cover	150 x 190	Absorbent
1	Tube holder	2.5 x 30	Hook and loop

*Ret/Crtn - Retailer/Carton

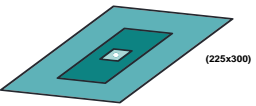
Extremity Drape PRIMARY PLUS					
	Ref. Sterile	Product Name	Size (cm)	Descriptive Feature	RET/CRTN
 (cm)	63634	Extremity sheet	225 x 300, 7	2-ply	12/24
	63633	Extremity drape	225 x 300, 5	Reinforced absorption patch (110 x 50cm)	12/24
	63632	Extremity drape	225 x 300, 3,5	Flexible area (27 x 20cm)	12/24

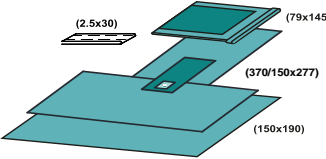
63731 Hand Set PRIMARY PLUS					RET/CRTN 5/10
	QTY	Product Name	Size (cm)	Descriptive Feature	
 (cm)	1	Mayo stand cover	79 x 145	Reinforced/absorbent	
	1	Hand drape	370/150 x 277	2-ply Reinforced absorption patch (90 x 50cm) Flexible area (26 x 19cm) Extremity hole (diameter 3.5cm)	
	1	Table cover	150 x 190	Absorbent	
	1	Tube holder	2.5 x 30	Hook and loop	

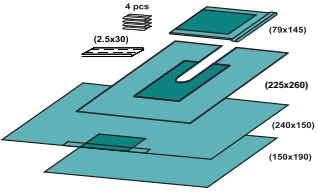
60811 Split Sheet Set PRIMARY PLUS					RET/CRTN 4/8
	QTY	Product Name	Size (cm)	Descriptive Feature	
 (cm)	1	Mayo stand cover	79 x 145	Reinforced/absorbent	
	4	Cellulose towel	17 x 8	Absorbent	
	1	Tube holder	2.5 x 30	Hook and loop	
	1	Split sheet	225 x 260	2-ply, Split 20 x 100cm, adhesive	
	1	Adhesive OP-sheet	240 x 150	2-ply, Adhesive edges, Reinforced patched area 60 x 25cm	
	1	Table cover	150 x 190	Absorbent	

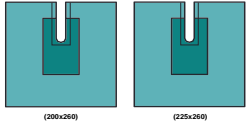
Split Sheet PRIMARY PLUS					
	Ref. Sterile	Product Name	Size (cm)	Descriptive Feature	RET/CRTN
 (cm)	63650	Split sheet	200 x 260	2-ply, Split 7 x 100cm, Adhesive	13/26
	63651	Split sheet	225 x 260	2-ply, Split 20 x 100cm, Adhesive	11/22

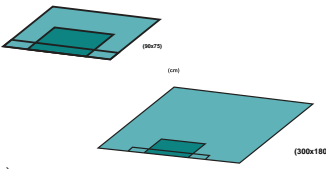
Adhesive OP-Towels/Sheets PRIMARY PLUS					
	Ref. Sterile	Product Name	Size (cm)	Descriptive Feature	RET/CRTN
 (cm)	63603	Adhesive OP-towel	90 x 75		33/66
	63604	Adhesive OP-towel	120 x 100		60/120
	63605	Adhesive OP-sheet	180 x 180	2-ply Adhesive, Reinforced patched area (60 x 25cm)	22/44
	63606	Adhesive OP-sheet	240x150		20/40
	63607	Adhesive OP-sheet	300 x 180		13/26

*Ret/Crtn - Retailer/Carton



 **WeCare**

We are committed
to do more with
fewer resources

BARRIER® ISCC* Drapes

Our new range of ISCC certified surgical drapes marks the next big step in the long journey, towards actively minimising our environmental footprint.

With infection control at front of mind, our mission is to deliver a product that does not compromise on quality, form or functionality. Our ISCC drapes offers the identical performance of our non-ISCC equivalents, the difference is the use of biobased materials that reduce the depletion of fossil oil and reduces CO₂ emissions.

At Mölnlycke® Health Care, sustainability is more than just a word. It's about taking responsibility for our business impact and developing sustainably.

Doing our part will require gradually reducing fossil-based CO₂ emissions in our supply chain, in our production, optimising our resource use and maintaining full traceability.

For now, this is just one step in the many to come in our journey toward a more sustainable future.

*International Sustainability & Carbon Certification. ISCC's mission is to protect forests, high-carbon stock lands and biodiversity, enable waste utilisation and increase traceability.

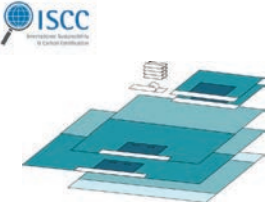
Universal Set Standard ISCC		7/14	60340
Ref. No.	QTY	Description	
	2	Adhesive OP-towels ISCC 90x75cm patched	
	4	Cellulose towels 18x25cm	
	1	OP-tape 9x49cm	
	1	Adhesive OP-sheet ISCC 175x175cm patched	
	1	Adhesive OP-sheet ISCC 240x150cm patched	
	1	Table cover 150x190cm	

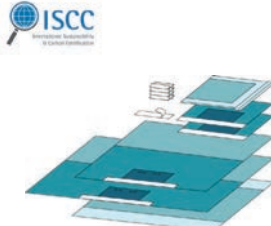
Universal Set Standard ISCC		6/12	60054
Ref. No.	QTY	Description	
	1	Mayo stand cover 79x145cm absorbent	
	2	Adhesive OP-towels ISCC 90x75cm patched	
	4	Cellulose towels 18x25cm	
	1	OP-tape 9x49cm	
	1	Adhesive OP-Sheet ISCC 175x175cm patched	
	1	Adhesive OP-Sheet ISCC 240x150cm patched	
	1	Table cover 150x190cm	

Adhesive OP-Towel ISCC		35/210	60500
Ref. No.	QTY	Description	
	60500	1	Adhesive OP-Towel ISCC 75x75cm

Adhesive OP-Towel ISCC		32/192	60677
Ref. No.	QTY	Description	
	60677	1	Adhesive OP-Towel ISCC 90x75cm

Adhesive OP-Sheet ISCC		45/90	60800
Ref. No.	QTY	Description	
	60800	1	Adhesive OP-Towel ISCC 90x75cm patched

Adhesive OP-Sheet ISCC		13/26	60750
Ref. No.	QTY	Description	
	60750	1	Adhesive OP-Towel ISCC 175x175cm

Our goal at Mölnlycke, is to create a frictionless flow in the operating room, where patient outcomes are prioritised, more operations can take place and healthcare professionals can thrive in their roles.

Mölnlycke provides a range of drapes, staff clothing and surgical instruments for the operating room. The products can be included in ProcedurePak® trays to increase efficiency or supplied single-packed.

The Mölnlycke Portal assists customers in assembling efficient ProcedurePak® trays with the right components, maximising value creation for customers.

The Operating Room Solution (ORS) business prioritises sustainability by offering a variety of products and services that aim to minimise the environmental impact. This includes our sustainable ISCC* certified products partly made up of renewable materials, sustainable packaging solutions and waste reduction initiatives. By utilising the Mölnlycke CO2 calculator tool, ORS provides customers with valuable information on the environmental impact of its products

Our Strategy

Efficiency is a key driver in the operating room. The trend to deliver more with less has been established over several years. The healthcare system is at a breaking point as it confronts staff shortages, while professionals are working under pressure, forced to conduct more procedures with less resources and spend substantial time on tasks that don't add value. ORS collaborates with customers to improve the standard of care and the efficiency and capacity of the operating room, by eliminating tasks not directly related to healthcare professionals' roles. Going forward, ORS will continue to deepen its impact in the operating room by establishing an ecosystem that adds value to the pre-, intra-, and post-operation procedure.

Revolutionise care for people and planet

www.molnlycke.com.au | www.molnlycke.co.nz

Mölnlycke, 12 Narabang Way, Level 4, Belrose, NSW, 2085. Phone 1800 005 231. The Mölnlycke trademark, name and logo is registered globally to one or more of the Mölnlycke Health Care Group of Companies. ©2023 Mölnlycke Health Care. All rights reserved. AU001264

